

LINEARlight Flex DIFFUSE IP67 connector

Accessoires pour les bandes LED flexibles

Caractéristiques produit

- Quick and easy installation
- Compatible with TEC Flex



Avantages produits

- Installation simple, ni outils, ni soudure nécessaires (CONNECTsystem)
- Durée d'installation réduite (CONNECTsystem)
- Peut être connecté à l'avant du module ou aux points de division (CONNECTsystem)
- De faible profondeur (CONNECTsystem)

Fiche de données gamme de produits

Fiche technique

Description produit	Dimensions & poids				Données logistiques
	Hauteur	Largeur	Longueur	Poids du produit	Nomenclature douanière
FX-DCS -G1-CM2PF-IP67-500-X5	19,0 mm	18,5 mm	26,6 mm	105,00 g	853669909900
FX-DCS -G1-CM2PF-IP67-TOPKIT5	30,0 mm	150,0 mm	260,0 mm	122,30 g	853669909900
FX-DCS -G1-CM2PF-IP67-SIDEKIT5	30,0 mm	150,0 mm	260,0 mm	118,10 g	853669909900
FX-DCS -G1-CM2PJ-IP67-0190-X5	19,0 mm	18,5 mm	26,6 mm	85,00 g	853669909900
FX-DCS -G1-CM2PJ-IP67-TOPKIT5	30,0 mm	150,0 mm	260,0 mm	102,30 g	853669909900
FX-DCS -G1-CM2PJ-IP67-SIDEKIT5	30,0 mm	150,0 mm	260,0 mm	98,10 g	853669909900
FX-DCS -G1-ECT-KIT20	11,6 mm	16,1 mm	9,2 mm	34,60 g	392690979000
FX-DCS -G1-ECS-KIT20	14,1 mm	12,0 mm	6,2 mm	26,20 g	392690979000
FX-DCS -G1-EHT-KIT20	11,6 mm	16,1 mm	17,0 mm	63,00 g	392690979000
FX-DCS -G1-EHS-KIT20	14,5 mm	12,4 mm	11,0 mm	51,40 g	392690979000
FX-DCS -G1-GL-25	30,0 mm	150,0 mm	100,0 mm	26,00 g	350610000000

Description produit	Environmental information Information according Art. 33 of EU Regulation (EC) 1907/2006 (REACH)			
	Date of Declaration	Primary Article Identifier	Candidate List Substance 1	Declaration No. in SCIP database
FX-DCS -G1-CM2PF-IP67-500-X5	30-08-2022	4052899451971	No declarable substances contained	No declarable substances contained
FX-DCS -G1-CM2PF-IP67-TOPKIT5	30-08-2022	4052899451995	No declarable substances contained	No declarable substances contained
FX-DCS -G1-CM2PF-IP67-SIDEKIT5	30-08-2022	4052899452015	No declarable substances contained	No declarable substances contained
FX-DCS -G1-CM2PJ-IP67-0190-X5	30-08-2022	4052899452039	No declarable substances contained	No declarable substances contained
FX-DCS -G1-CM2PJ-IP67-TOPKIT5	30-08-2022	4052899452053		In work
FX-DCS -G1-CM2PJ-IP67-SIDEKIT5	30-08-2022	4052899452077	No declarable substances contained	No declarable substances contained
FX-DCS -G1-ECT-KIT20	30-08-2022	4052899452107	No declarable substances contained	No declarable substances contained
FX-DCS -G1-ECS-KIT20	30-08-2022	4052899452121	No declarable substances contained	No declarable substances contained
FX-DCS -G1-EHT-KIT20	30-08-2022	4052899452176		In work
FX-DCS -G1-EHS-KIT20	30-08-2022	4052899452206	No declarable substances contained	No declarable substances contained
FX-DCS -G1-GL-25	30-08-2022	4052899452244	No declarable substances contained	No declarable substances contained

Fiche de données gamme de produits

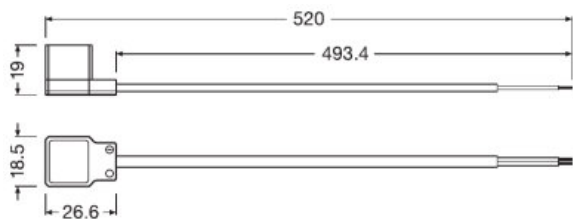

728401_Middle power feeder Flex Diffuse

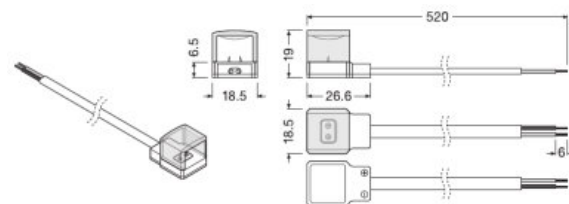

728697_LINEARlight FLEX DIFFUSE FX-DCS-G1-CM2PF-IP67-0500-X5

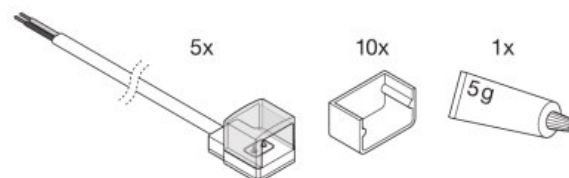
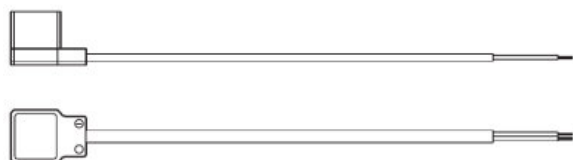

728433_Middle power feeder Flex Diffuse

728701_LINEARlight FLEX DIFFUSE FX-DCS-G1-CM2PF-IP67-TOPKIT5

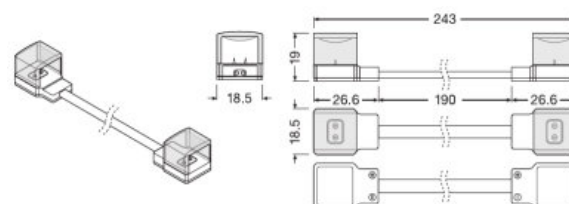
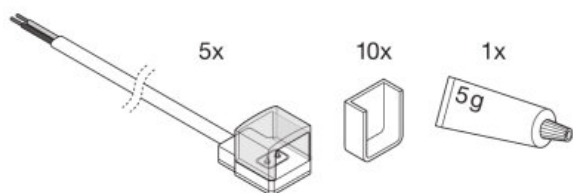

728707_LINEARlight FLEX DIFFUSE FX-DCS-G1-CM2PF-IP67-SIDEKIT5

728698_LINEARlight FLEX DIFFUSE FX-DCS-G1-CM2PJ-IP67-0190-X5

Fiche de données gamme de produits

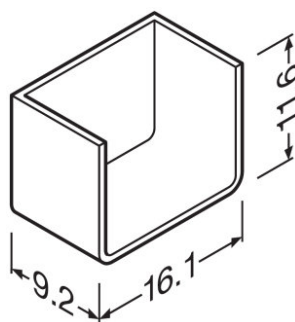

728402_Single sided endcaps for top-bending modules

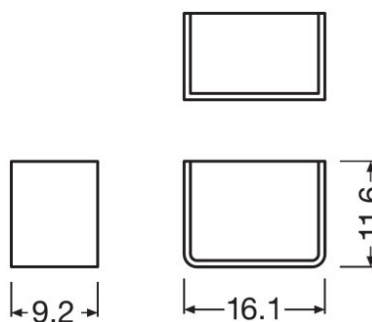

728403_Single sided endcaps for top-bending modules

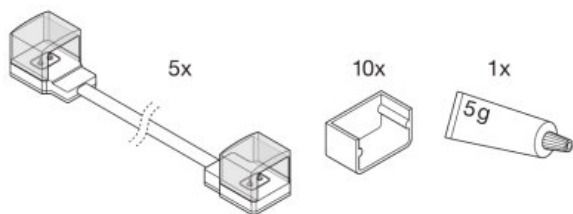

728702_LINEARlight FLEX DIFFUSE FX-DCS-G1-CM2PJ-IP67-TOPKIT5

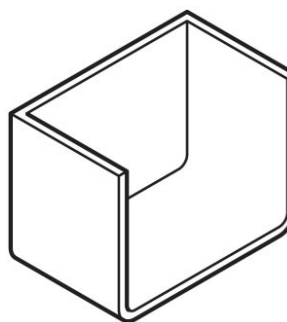

728434_Single sided endcaps for top-bending modules

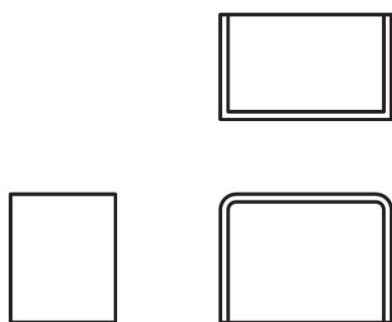

728435_Single sided endcaps for top-bending modules

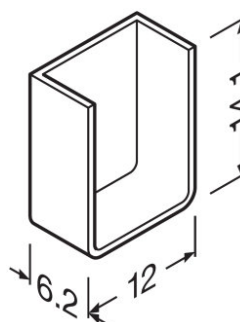

728404_Single sided endcaps for side-bending modules

Fiche de données gamme de produits

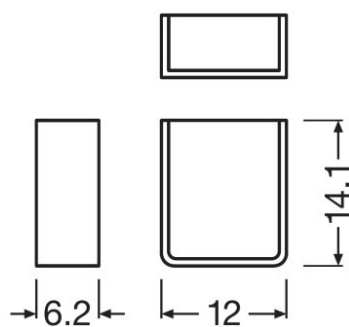

728405_Single sided endcaps for side-bending modules

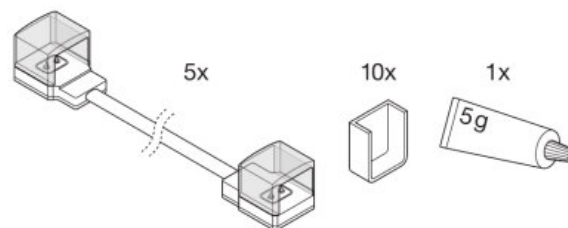

728708_LINEARlight FLEX DIFFUSE FX-DCS-G1-CM2PJ-IP67-SIDEKIT5

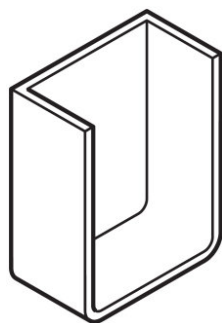

728436_Single sided endcaps for side-bending modules

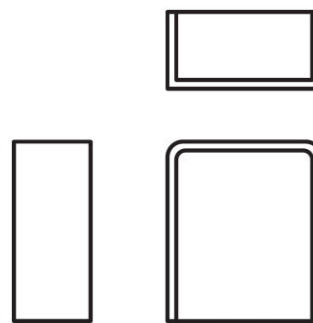

728437_Single sided endcaps for side-bending modules

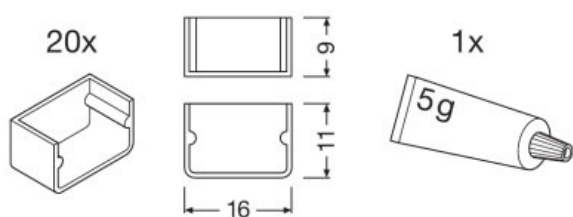

728687_DS063_PG_LINEARlight_FLEX_DIFFUSE_FX-DCS-G1-ECT-KIT20

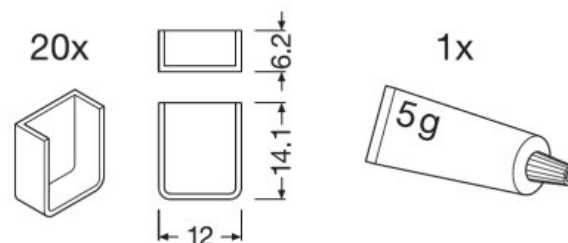

728705_LINEARlight FLEX DIFFUSE FX-DCS-G1-ECS-KIT20

Fiche de données gamme de produits

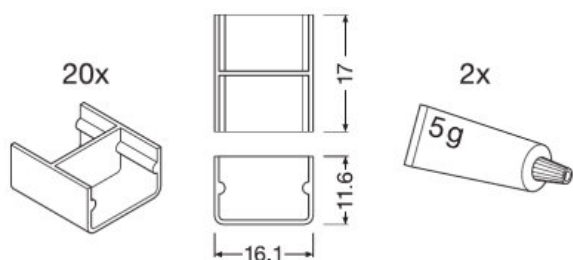

728700_LINEARlight FLEX DIFFUSE FX-DCS-G1-EHT-KIT20

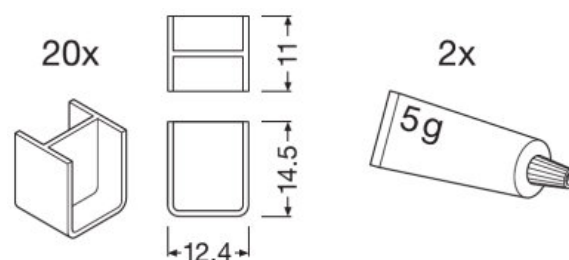

728706_LINEARlight FLEX DIFFUSE FX-DCS-G1-EHS-KIT20

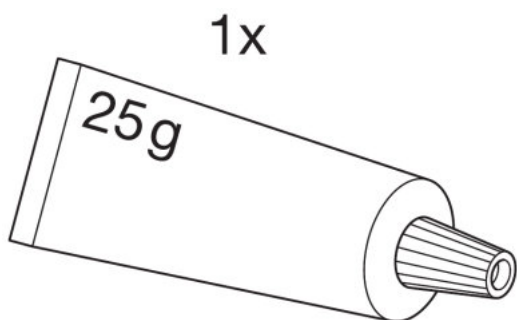

728711_LINEARlight FLEX DIFFUSE FX-DCS-G1-GL-25

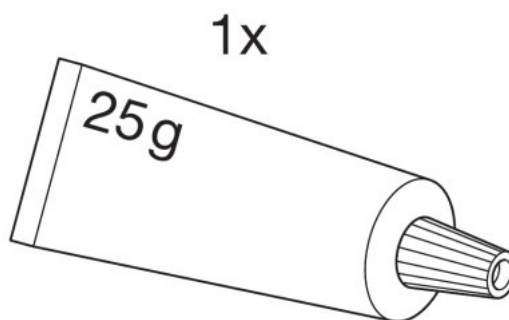

729229_LINEARlight FLEX DIFFUSE FX-DCS-G1-GL-25

Conseil d'application

Pour plus d'informations sur les applications et les graphiques, veuillez vous référer à la fiche de données produit.

Support de vente et support technique

Support de vente et support technique www.osram.fr

Données de téléchargement

Dossier



User instruction
LINEARLIGHT Flex Diffuse Installation Guide - Naed Version (EN)

Fiche de données gamme de produits



Brochures
Light is freedom of design (EN)

Données logistiques

Code produit	Description produit	Unité d'emballage (Pièces/Unité)	Dimensions (longueur x largeur x hauteur)	Volume	Poids brut
4052899451971	FX-DCS -G1-CM2PF-IP67-500-X5	Carton de regroupement 10	195 mm x 295 mm x 160 mm	9.20 dm ³	1295.00 g
4052899451995	FX-DCS -G1-CM2PF-IP67-TOPKIT5	Carton de regroupement 10	195 mm x 295 mm x 160 mm	9.20 dm ³	1468.00 g
4052899452015	FX-DCS -G1-CM2PF-IP67-SIDEKIT5	Carton de regroupement 10	195 mm x 295 mm x 160 mm	9.20 dm ³	1426.00 g
4052899452039	FX-DCS -G1-CM2PJ-IP67-0190-X5	Carton de regroupement 10	195 mm x 295 mm x 160 mm	9.20 dm ³	1095.00 g
4052899452053	FX-DCS -G1-CM2PJ-IP67-TOPKIT5	Carton de regroupement 10	195 mm x 295 mm x 160 mm	9.20 dm ³	1268.00 g
4052899452077	FX-DCS -G1-CM2PJ-IP67-SIDEKIT5	Carton de regroupement 10	195 mm x 295 mm x 160 mm	9.20 dm ³	1226.00 g
4052899452107	FX-DCS -G1-ECT-KIT20	Carton de regroupement 10	200 mm x 200 mm x 110 mm	4.40 dm ³	496.00 g
4052899452121	FX-DCS -G1-ECS-KIT20	Carton de regroupement 10	200 mm x 200 mm x 110 mm	4.40 dm ³	412.00 g
4052899452176	FX-DCS -G1-EHT-KIT20	Carton de regroupement 10	200 mm x 200 mm x 110 mm	4.40 dm ³	780.00 g
4052899452206	FX-DCS -G1-EHS-KIT20	Carton de regroupement 10	200 mm x 200 mm x 110 mm	4.40 dm ³	664.00 g
4052899452244	FX-DCS -G1-GL-25	Carton de regroupement 20	200 mm x 200 mm x 110 mm	4.40 dm ³	760.00 g

Le code produit mentionné décrit la petite quantité d'unité qui peut être commandée. Une unité peut contenir un ou plusieurs produits. Lorsque vous passez la commande, merci de bien vouloir entrer une unité ou un multiple d'une unité.

Avertissement

Sous réserve de modifications. Sauf erreur ou omission. Veuillez à toujours utiliser la version la plus récente.