

## SIRIUS HRI

High-pressure discharge lamps with reflector



### Domaines d'application

- Architecture & Architainment

### Avantages produits

- Lightweight and compact reflector lamps
- Perfectly suited for small and lightweight moving heads
- Conception optimisée de la capsule permettant un fonctionnement dans n'importe quelle position
- High luminance through very short arc and high pressure
- Lumière brillante pour des effets lumineux éclatants
- Longue durée de vie
- Easy lamp replacement
- Stable light output over the entire lifetime



Fiche de données gamme de produits

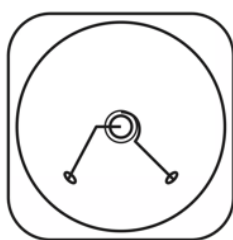
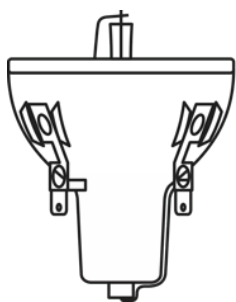

666507\_SIRIUS HRI 100W

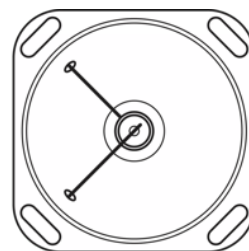
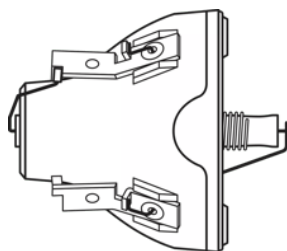

350611\_SIRIUS HRI 132W

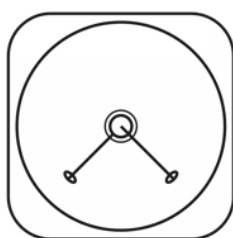
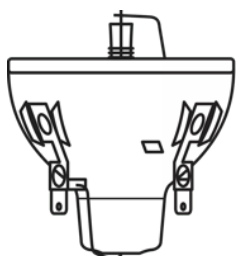

488735\_SIRIUS HRI 132W

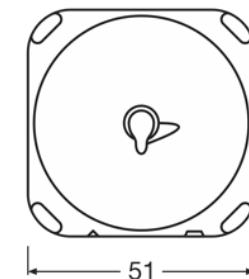
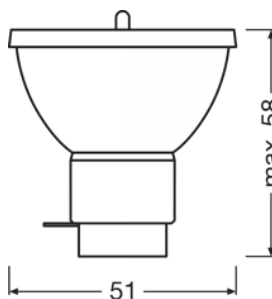

SIRIUS HRI 251W

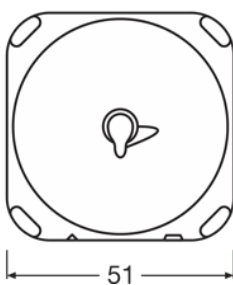
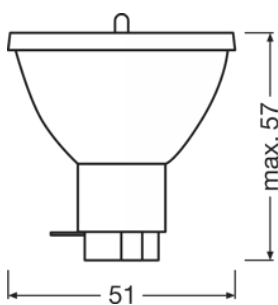

SIRIUS HRI 295 W

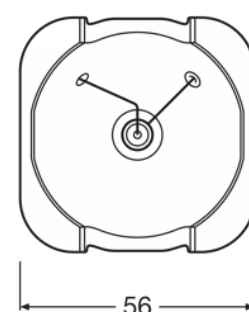
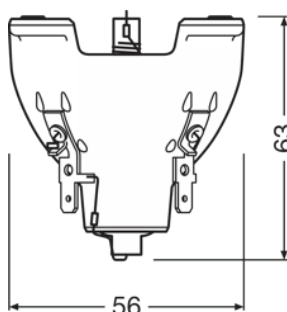

501950\_SIRIUS HRI 330W

Fiche de données gamme de produits

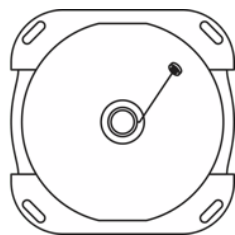
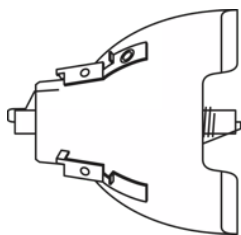

333382\_SIRIUS HRI 330W

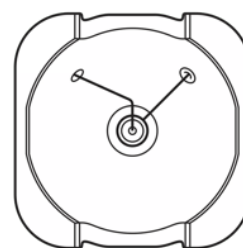
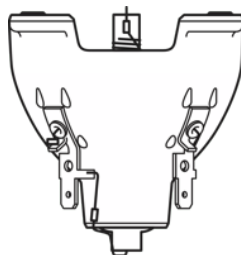

501965\_SIRIUS HRI 330W

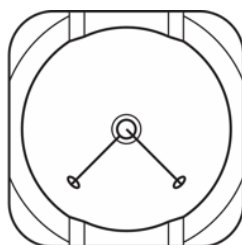
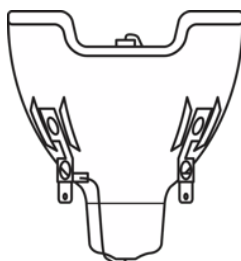

488771\_SIRIUS HRI 330W X8

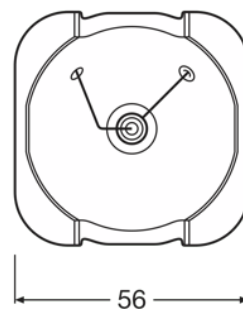
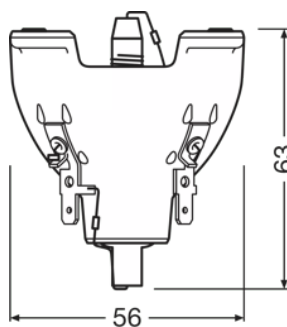

501949\_Sirius HRI 330W XL

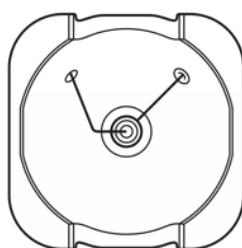
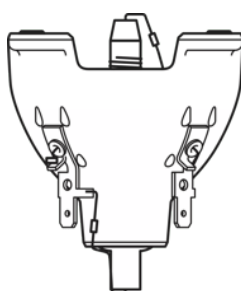

501963\_Sirius HRI 330W XL

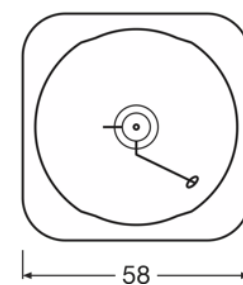
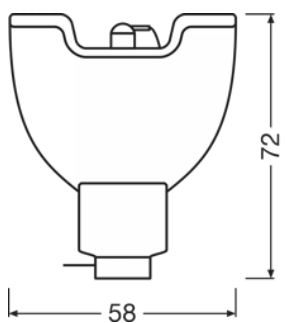

SIRIUS HRI 371W

Fiche de données gamme de produits

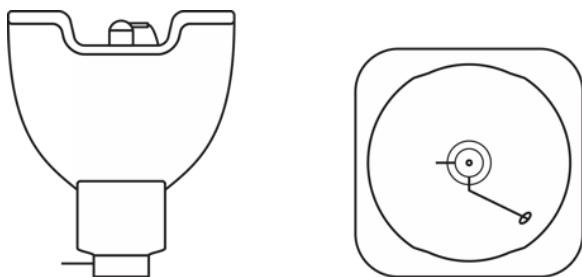

SIRIUS HRI 371W

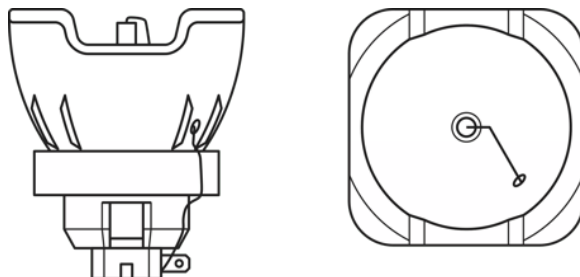

668858\_SIRIUS HRI 440W

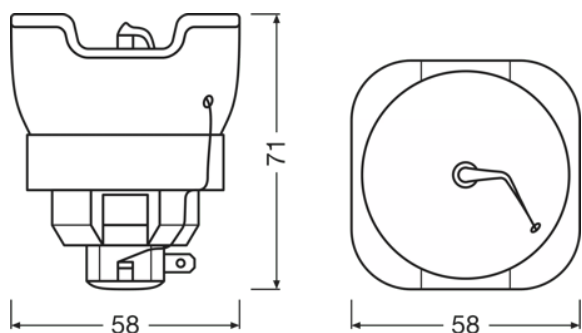

SIRIUS HRI 580 F

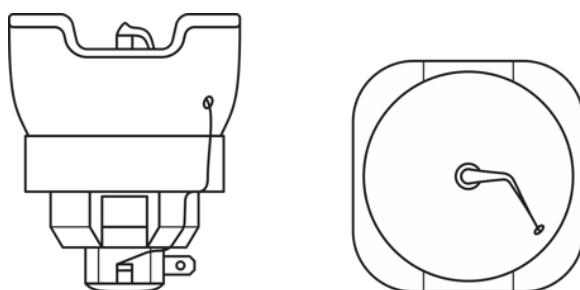

SIRIUS HRI 580 F

## Fiche de données gamme de produits

### Fiche technique

Description produit	Données électriques		Données photométriques				Données photométriques
	Puissance nominale	Intensité nominale	Flux lumineux nominale	Temp. de couleur	Ra Indice de rendu des couleurs	Plage de température de couleur maximale	Focale
SIRIUS HRI 100 W	100.00 W	18 A	3680 lm	9000 K	60	9300 K	30.0 mm
SIRIUS HRI 132 W SC	132.00 W	18 A	5150 lm	9200 K	60	9200 K	37.7 mm
SIRIUS HRI 140 W RO	140.00 W	19 A	5400 lm	9200 K	60	9200 K	37.7 mm
SIRIUS HRI 190 W+	190.00 W	27 A	8100 lm	8200 K	73		
SIRIUS HRI 230 W	230.00 W	33 A	9500 lm	8000 K	75	8000 K	34,5 mm
SIRIUS HRI 231 W	231.00 W	33 A	10800 lm	8000 K	75		
SIRIUS HRI 251 W	250.00 W	35 A	12000 lm	8000 K	77		
SIRIUS HRI 260 W PRO	260.00 W	37 A	13500 lm	7800 K	79		
SIRIUS HRI 280 W	280.00 W	4 A	11500 lm	7800 K	78	7800 K	35.5 mm
SIRIUS HRI 280 W RO	280.00 W	4 A	11500 lm	7800 K	78		
SIRIUS HRI 281 W	281.00 W	4 A	13000 lm	7800 K	78		
SIRIUS HRI 295 W	295.00 W	4.1 A	11300 lm	7800 K	78		
SIRIUS HRI 310 W	310.00 W	45 A	15000 lm	8000 K	84		
SIRIUS HRI 310 W RO	310.00 W	48 A	13000 lm	8500 K	78		
SIRIUS HRI 310 W PRO	310.00 W	5 A	15500 lm	7650 K	85		
SIRIUS HRI 311 W	310.00 W	33 A	14500 lm	8000 K	75		
SIRIUS HRI 330 W	330.00 W	5 A	18000 lm	7400 K	86	7400 K	31.0 mm
SIRIUS HRI 330 W X8	330.00 W	44 A	18000 lm	8000 K	85		
SIRIUS HRI 330 W XL	330.00 W	5 A	16500 lm	7250 K	71		
SIRIUS HRI 371 W	371.00 W	5 A	18300 lm	7650 K	85		
SIRIUS HRI 371 W S	371.00 W	5 A	19800 lm	7650 K	85		
SIRIUS HRI 371 W +	370.00 W	5 A	18300 lm	7650 K	85		
HRI 371 W S +	370.00 W	5 A	19800 lm	7650 K	85		
SIRIUS HRI 381 W S	380.00 W	5 A	20000 lm	7700 K	85		
SIRIUS HRI 380 W Pro	380.00 W	5 A	20000 lm	7700 K	85		
SIRIUS HRI 380 W S PRO	380.00 W	5 A	20000 lm	7700 K	85		
SIRIUS HRI 382 W	382.00 W	54 A	21000 lm	7650 K	85		
SIRIUS HRI 382 W S	380.00 W	54 A	20000 lm	7650 K	85		
SIRIUS HRI 420 W	420.00 W	5 A	22000 lm	7700 K	85		
SIRIUS HRI 420 W S	420.00 W	5 A	21000 lm	7700 K	85		
SIRIUS HRI 440 W	440.00 W	53 A	20000 lm	7000 K	80	7000 K	41.0 mm
SIRIUS HRI 440 W +	440.00 W	53 A	22800 lm	7000 K	80		
SIRIUS HRI 440 W H	440.00 W	53 A	18000 lm	7000 K	75		
SIRIUS HRI 440 W S	440.00 W	44 A	22800 lm	7000 K	80		
SIRIUS HRI 440 W X	440.00 W	53 A	22800 lm	7000 K	80		
SIRIUS HRI 461 W	461.00 W	53 A	24000 lm	7500 K	80		
SIRIUS HRI 461 W S	461.00 W	53 A	24000 lm	7500 K	80		

## Fiche de données gamme de produits

Description produit	Données électriques		Données photométriques			Données photométriques
	Puissance nominale	Intensité nominale	Flux lumineux nominale	Temp. de couleur	Ra Indice de rendu des couleurs	Plage de température de couleur maximale
SIRIUS HRI 462 W	295.00 W	6.20 A	24000 lm	7900 K	85	
SIRIUS HRI 470 W	470.00 W	53 A	20500 lm	7000 K	80	
SIRIUS HRI 470 W S	470.00 W	53 A	21500 lm	7000 K	80	
SIRIUS HRI 470 W RO	470.00 W	5.3 A	19500 lm	7500 K	80	
SIRIUS HRI 470 W XL	470.00 W	53 A	24000 lm	7500 K	80	
SIRIUS HRI 471 W SN	471.00 W	53 A	20000 lm	7500 K	80	
SIRIUS HRI 550 W	550.00 W	6.1 A	28000 lm	7000 K	75	
SIRIUS HRI 550 W XL	550.00 W	6.1 A	28000 lm	7500 K	75	
HRI 580 W F	580.00 W	61 A	29500 lm	7000 K	75	

Description produit	Diamètre de la vitre	Dimensions & poids			Durée de vie
		Diamètre	Longueur	Forme de la lampe	Durée de vie
SIRIUS HRI 100 W	5x3.8 mm	45.0 mm	53.0 mm	-	6000 h
SIRIUS HRI 132 W SC	5x3.8 mm	46.0 mm	max. 44 mm	-	6000 h
SIRIUS HRI 140 W RO	5x3.8 mm	46.0 mm	max. 44 mm	-	6000 h
SIRIUS HRI 190 W+		51.0 mm	54.5 mm		3000 h
SIRIUS HRI 230 W	5x3.8 mm	51.0 mm	54.5 mm	-	2500 h
SIRIUS HRI 231 W		51.0 mm	50.0 mm		2000 h
SIRIUS HRI 251 W		51.0 mm	61.0 mm		3000 h
SIRIUS HRI 260 W PRO		51.0 mm	50.0 mm		6000 h
SIRIUS HRI 280 W	5x3.8 mm	51.0 mm	54.5 mm	-	2000 h
SIRIUS HRI 280 W RO		51.0 mm	54.5 mm		2000 h
SIRIUS HRI 281 W		51.0 mm	50.0 mm		2000 h
SIRIUS HRI 295 W		51.0 mm	53.5 mm		2500 h
SIRIUS HRI 310 W		51.0 mm	53.5 mm		2500 h
SIRIUS HRI 310 W RO		60.0 mm	67.0 mm		4000 h
SIRIUS HRI 310 W PRO		58.0 mm	72.0 mm		6000 h
SIRIUS HRI 311 W		51.0 mm	50.0 mm		1500 h
SIRIUS HRI 330 W	8.0 mm	56.0 mm	63.0 mm	-	1500 h
SIRIUS HRI 330 W X8		58.0 mm	66.0 mm		1500 h
SIRIUS HRI 330 W XL		56.0 mm	63.0 mm		1500 h
SIRIUS HRI 371 W		58.0 mm	72.0 mm		1500 h
SIRIUS HRI 371 W S		58.0 mm	72.0 mm		1500 h
SIRIUS HRI 371 W +		58.0 mm	72.0 mm		3000 h
HRI 371 W S +		58.0 mm	72.0 mm		3000 h
SIRIUS HRI 381 W S		58.0 mm	72.0 mm		2500 h
SIRIUS HRI 380 W Pro		58.0 mm	72.0 mm		2500 h
SIRIUS HRI 380 W S PRO		58.0 mm	72.0 mm		6000 h
SIRIUS HRI 382 W		58.0 mm	72.0 mm		2500 h

## Fiche de données gamme de produits

Description produit	Diamètre de la vitre	Dimensions & poids			Durée de vie
		Diamètre	Longueur	Forme de la lampe	Durée de vie
SIRIUS HRI 382 W S		58.0 mm	72.0 mm		2500 h
SIRIUS HRI 420 W		58.0 mm	72.0 mm		2500 h
SIRIUS HRI 420 W S		58.0 mm	72.0 mm		2500 h
SIRIUS HRI 440 W	8.0 mm	58.0 mm	71.0 mm	-	1500 h
SIRIUS HRI 440 W +		58.0 mm	71.0 mm		1500 h
SIRIUS HRI 440 W H		65.0 mm	60.0 mm		1500 h
SIRIUS HRI 440 W S		11.8 mm	71.0 mm		1500 h
SIRIUS HRI 440 W X		58.0 mm	71.0 mm		1500 h
SIRIUS HRI 461 W		60.0 mm	67.0 mm		1500 h
SIRIUS HRI 461 W S		60.0 mm	67.0 mm		1500 h
SIRIUS HRI 462 W		58.0 mm	72.0 mm		2000 h
SIRIUS HRI 470 W		58.0 mm	71.0 mm		1500 h
SIRIUS HRI 470 W S		58.0 mm	71.0 mm		1500 h
SIRIUS HRI 470 W RO		60.0 mm	67.0 mm		1500 h
SIRIUS HRI 470 W XL		60.0 mm	67.0 mm		1500 h
SIRIUS HRI 471 W SN		60.0 mm	67.0 mm		1500 h
SIRIUS HRI 550 W		60.0 mm	67.0 mm		1500 h
SIRIUS HRI 550 W XL		60.0 mm	67.0 mm		1500 h
HRI 580 W F		65.0 mm	65.0 mm		1000 h

Description produit	Capacités		Certificats & Normes	Environmental information according Art. 33 of EU Regulation (EC) 1907/2006 (REACH)
	Position de fonctionnement	Refroidissement	EEI – Classe énergétique	Date of Declaration
SIRIUS HRI 100 W	Universel	Forcé	B	06-03-2024
SIRIUS HRI 132 W SC	Universel	Forcé	A	06-03-2024
SIRIUS HRI 140 W RO	Universel	Forcé	A	06-03-2024
SIRIUS HRI 190 W+				07-03-2024
SIRIUS HRI 230 W	Universel	Forcé	A	05-03-2024
SIRIUS HRI 231 W	Universel		A	06-03-2024
SIRIUS HRI 251 W				07-03-2024
SIRIUS HRI 260 W PRO				07-03-2024
SIRIUS HRI 280 W	Universel	Forcé	A	05-03-2024
SIRIUS HRI 280 W RO	Universel		A	06-03-2024
SIRIUS HRI 281 W	Universel		A	06-03-2024
SIRIUS HRI 295 W				26-10-2023
SIRIUS HRI 310 W				07-12-2023
SIRIUS HRI 310 W RO	Universel			07-12-2023
SIRIUS HRI 310 W PRO				07-03-2024

## Fiche de données gamme de produits

Description produit	Capacités		Certificats & Normes	Environmental information according Art. 33 of EU Regulation (EC) 1907/2006 (REACH)
	Position de fonctionnement	Refroidissement	EEI – Classe énergétique	Date of Declaration
SIRIUS HRI 311 W				07-03-2024
SIRIUS HRI 330 W	Universel	Forcé		05-03-2024
SIRIUS HRI 330 W X8	Universel		A	06-03-2024
SIRIUS HRI 330 W XL	Universel			06-03-2024
SIRIUS HRI 371 W	Universel			06-03-2024
SIRIUS HRI 371 W S	Universel			06-03-2024
SIRIUS HRI 371 W +				07-03-2024
HRI 371 W S +				15-03-2024
SIRIUS HRI 381 W S				22-12-2023
SIRIUS HRI 380 W Pro				07-03-2024
SIRIUS HRI 380 W S PRO				22-12-2023
SIRIUS HRI 382 W				07-12-2023
SIRIUS HRI 382 W S				07-12-2023
SIRIUS HRI 420 W				07-03-2024
SIRIUS HRI 420 W S				26-10-2023
SIRIUS HRI 440 W	Universel	Forcé	A	06-03-2024
SIRIUS HRI 440 W +				22-12-2023
SIRIUS HRI 440 W H	Universel			06-03-2024
SIRIUS HRI 440 W S	Universel		A	06-03-2024
SIRIUS HRI 440 W X				07-03-2024
SIRIUS HRI 461 W	Universel			06-03-2024
SIRIUS HRI 461 W S	Universel			06-03-2024
SIRIUS HRI 462 W				26-10-2023
SIRIUS HRI 470 W	Universel			22-12-2023
SIRIUS HRI 470 W S	Universel			06-03-2024
SIRIUS HRI 470 W RO	Universel		A	17-05-2024
SIRIUS HRI 470 W XL	Universel			06-03-2024
SIRIUS HRI 471 W SN	Universel			06-03-2024
SIRIUS HRI 550 W				06-03-2024
SIRIUS HRI 550 W XL				27-10-2023
HRI 580 W F				22-12-2023

Description produit	Primary Article Identifier	Candidate List Substance 1	Declaration No. in SCIP database
SIRIUS HRI 100 W	4052899321656   4052899329119	No declarable substances contained	No declarable substances contained



## Fiche de données gamme de produits

Description produit	Primary Article Identifier	Candidate List Substance 1	Declaration No. in SCIP database
SIRIUS HRI 132 W SC	4052899011335   4052899028708   4052899197404	No declarable substances contained	In work
SIRIUS HRI 140 W RO	4052899224056   4052899258969	No declarable substances contained	In work
SIRIUS HRI 190 W+	4008321866592   4052899475397	No declarable substances contained	In work
SIRIUS HRI 230 W	4008321678225   4008321810311	No declarable substances contained	In work
SIRIUS HRI 231 W	4052899512634   4052899553521   4062172041430   4062172128681   4062172212311	No declarable substances contained	In work
SIRIUS HRI 251 W	4062172212458   4062172212434	No declarable substances contained	No declarable substances contained
SIRIUS HRI 260 W PRO	4062172118941   4062172118927	No declarable substances contained	In work
SIRIUS HRI 280 W	4008321734303   4008321810342	No declarable substances contained	In work
SIRIUS HRI 280 W RO	4052899082151   4052899110397	No declarable substances contained	In work
SIRIUS HRI 281 W	4052899553552   4062172041454   4062172128704	No declarable substances contained	In work
SIRIUS HRI 295 W	4062172283328   4062172283304	No declarable substances contained	No declarable substances contained
SIRIUS HRI 310 W	4062172202169   4062172202183		In work
SIRIUS HRI 310 W RO	4062172013536   4062172063449   4062172140867   4062172140843	No declarable substances contained	In work
SIRIUS HRI 310 W PRO	4062172085304   4062172169424   4062172169455	No declarable substances contained	In work
SIRIUS HRI 311 W	4062172169363		In work
SIRIUS HRI 330 W	4008321754448   4008321810373	No declarable substances contained	In work
SIRIUS HRI 330 W X8	4052899140295   4052899140325   4052899224346	No declarable substances contained	In work
SIRIUS HRI 330 W XL	4008321848765   4052899195431	No declarable substances contained	In work
SIRIUS HRI 371 W	4062172057004   4062172056984   4052899558649   4052899558670	No declarable substances contained	In work
SIRIUS HRI 371 W S	4062172056953   4062172056939   4052899558618	No declarable substances contained	In work

## Fiche de données gamme de produits

Description produit	Primary Article Identifier	Candidate List Substance 1	Declaration No. in SCIP database
SIRIUS HRI 371 W +	4062172110341   4062172110327	No declarable substances contained	In work
HRI 371 W S +	4062172110396   4062172110372   4062172390729	No declarable substances contained	In work
SIRIUS HRI 381 W S	4062172226240   4062172226226	No declarable substances contained	In work
SIRIUS HRI 380 W Pro	4062172168625   4062172168601	No declarable substances contained	In work
SIRIUS HRI 380 W S PRO	4062172168335   4062172168311	No declarable substances contained	No declarable substances contained
SIRIUS HRI 382 W	4062172047135   4062172326131	No declarable substances contained	In work
SIRIUS HRI 382 W S	4062172033541   4062172326100	No declarable substances contained	No declarable substances contained
SIRIUS HRI 420 W	4062172192750   4062172192736	No declarable substances contained	In work
SIRIUS HRI 420 W S	4062172192705   4062172192682   4062172392938   4062172392891   4062172393225   4062172393201	No declarable substances contained	In work
SIRIUS HRI 440 W	4052899222212   4052899259096   4052899553644   4052899570566   4052899587892	No declarable substances contained	In work
SIRIUS HRI 440 W +	4062172047333   4062172348874	No declarable substances contained	No declarable substances contained
SIRIUS HRI 440 W H	4052899509528   4052899576735	No declarable substances contained	In work
SIRIUS HRI 440 W S	4052899276543   4052899329140	No declarable substances contained	In work
SIRIUS HRI 440 W X	4062172017442	No declarable substances contained	No declarable substances contained
SIRIUS HRI 461 W	4052899532274   4052899553613	No declarable substances contained	No declarable substances contained
SIRIUS HRI 461 W S	4052899532298   4052899553583	No declarable substances contained	No declarable substances contained
SIRIUS HRI 462 W	4062172302128   4062172302104	No declarable substances contained	No declarable substances contained
SIRIUS HRI 470 W	4052899580961   4062172169332	No declarable substances contained	No declarable substances contained
SIRIUS HRI 470 W S	4052899580985   4062172169301	No declarable substances contained	In work
SIRIUS HRI 470 W RO	4052899476998   4052899477018   4062172392556	No declarable substances contained	In work

## Fiche de données gamme de produits

Description produit	Primary Article Identifier	Candidate List Substance 1	Declaration No. in SCIP database
SIRIUS HRI 470 W XL	4052899581166   4062172017473   4062172168281	No declarable substances contained	In work
SIRIUS HRI 471 W SN	4052899581005   4062172040358	No declarable substances contained	In work
SIRIUS HRI 550 W	4062172008761   4062172078122	No declarable substances contained	In work
SIRIUS HRI 550 W XL	4062172008785   4062172168236   4062172168212	No declarable substances contained	In work
HRI 580 W F	4062172085267	No declarable substances contained	No declarable substances contained

## Fiche de données gamme de produits

---

### Consignes de sécurité

En raison de leur luminance élevée, des émissions d'UV et d'une pression interne élevée, les lampes SIRIUS HRI ne doivent fonctionner que dans des boîtiers fermés spécialement conçus à cet effet. Des filtres appropriés doivent ramener l'émission d'UV à un niveau acceptable. Il y a dégagement de mercure si la lampe est cassée. Prendre des précautions de sécurité spéciales. Des informations relatives à la sécurité et la manipulation sont disponibles sur demande, ou figurent dans le dépliant joint avec la lampe, ou dans les instructions d'utilisation.

---

### Conseil d'application

Pour plus d'informations sur les applications et les graphiques, veuillez vous référer à la fiche de données produit.

---

### Avertissement

Sous réserve de modifications. Sauf erreur ou omission. Veuillez à toujours utiliser la version la plus récente.